

TECHNICAL DATA
DATA SHEET 4690, REV. -

HERMETIC POWER SCHOTTKY RECTIFIER Very Low Forward Voltage

Applications:

- Switching Power Supply • Converters • Free-Wheeling Diodes • Polarity Protection Diode

Features:

- Soft Reverse Recovery at Low and High Temperature
- Very Low Forward Voltage Drop
- Low Power Loss, High Efficiency
- High Surge Capacity
- Guard Ring for Enhanced Durability and Long Term Reliability
- Guaranteed Reverse Avalanche Characteristics

Maximum Ratings:

Characteristics	Symbol	Condition	Max.	Units
Peak Inverse Voltage	V_{RWM}	-	15	V
Max. Average Forward Current	$I_{F(AV)}$	50% duty cycle, rectangular wave form (Single/Doubler)	30	A
Max. Average Forward Current	$I_{F(AV)}$	50% duty cycle, rectangular wave form (Common Cathode/Common Anode)	45	A
Max. Peak One Cycle Non-Repetitive Surge Current	I_{FSM}	8.3 ms, half Sine wave (per leg)	200	A
Max. Thermal Resistance	$R_{\theta JC}$	(Single)	0.77	°C/W
Max. Thermal Resistance	$R_{\theta JC}$	(Common Cathode/Common Anode/Doubler) (per leg)	0.39	°C/W
Max. Junction Temperature	T_J	-	-65 to +100	°C
Max. Storage Temperature	T_{stg}	-	-65 to +100	°C

Electrical Characteristics:

Characteristics	Symbol	Condition	Max.	Units
Max. Forward Voltage Drop	V_{F1}	@ 30A, Pulse, $T_J = 25\text{ °C}$ (per leg)	0.54	V
	V_{F2}	@ 30A, Pulse, $T_J = 125\text{ °C}$ (per leg)	0.50	V
Max. Reverse Current	I_{R1}	@ $V_R = 15V$, Pulse, $T_J = 25\text{ °C}$ (per leg)	14	mA
	I_{R2}	@ $V_R = 15V$, Pulse, $T_J = 125\text{ °C}$ (per leg)	680	mA
Max. Junction Capacitance	C_T	@ $V_R = 5V$, $T_C = 25\text{ °C}$ $f_{SIG} = 1MHz$, $V_{SIG} = 50mV$ (p-p) (per leg)	2400	pF

TECHNICAL DATA
DATA SHEET 4690, REV. -

Mechanical Dimensions: In Inches / mm

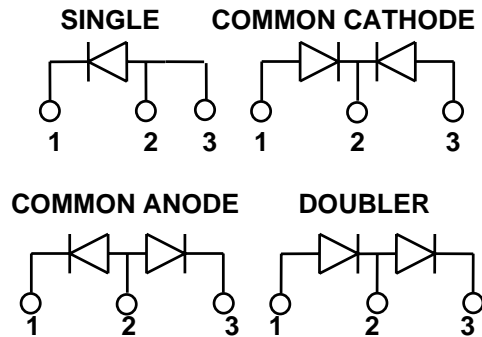
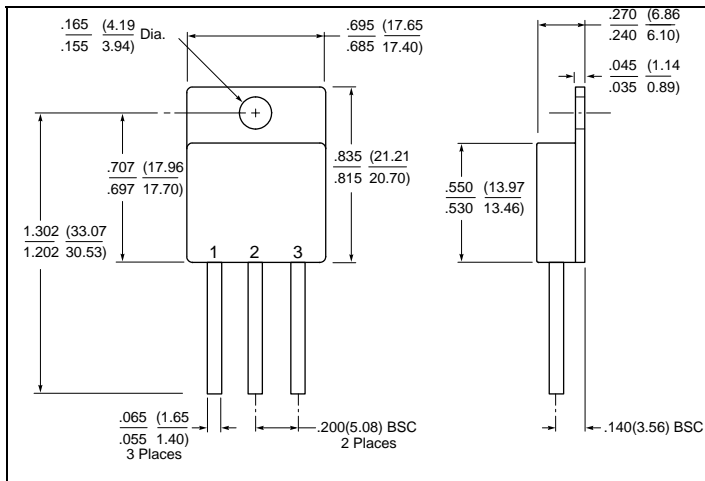

TO-258

PINOUT TABLE

TYPE	PIN 1	PIN 2	PIN 3
SINGLE RECTIFIER	CATHODE	ANODE	ANODE
DUAL RECTIFIER, COMMON CATHODE (P)	ANODE 1	COMMON CATHODE	ANODE 2
DUAL RECTIFIER, COMMON ANODE (N)	CATHODE 1	COMMON ANODE	CATHODE 2
DUAL RECTIFIER, DOUBLER (D)	ANODE	CATHODE/ANODE	CATHODE

Note: The V_f curves shown are for the SD175SD15 un-packaged die only.

TECHNICAL DATA

DISCLAIMER:

- 1- The information given herein, including the specifications and dimensions, is subject to change without prior notice to improve product characteristics. Before ordering, purchasers are advised to contact the Sensitron Semiconductor sales department for the latest version of the datasheet(s).
- 2- In cases where extremely high reliability is required (such as use in nuclear power control, aerospace and aviation, traffic equipment, medical equipment, and safety equipment), safety should be ensured by using semiconductor devices that feature assured safety or by means of users' fail-safe precautions or other arrangement.
- 3- In no event shall Sensitron Semiconductor be liable for any damages that may result from an accident or any other cause during operation of the user's units according to the datasheet(s). Sensitron Semiconductor assumes no responsibility for any intellectual property claims or any other problems that may result from applications of information, products or circuits described in the datasheets.
- 4- In no event shall Sensitron Semiconductor be liable for any failure in a semiconductor device or any secondary damage resulting from use at a value exceeding the absolute maximum rating.
- 5- No license is granted by the datasheet(s) under any patents or other rights of any third party or Sensitron Semiconductor.
- 6- The datasheet(s) may not be reproduced or duplicated, in any form, in whole or part, without the expressed written permission of Sensitron Semiconductor.
- 7- The products (technologies) described in the datasheet(s) are not to be provided to any party whose purpose in their application will hinder maintenance of international peace and safety nor are they to be applied to that purpose by their direct purchasers or any third party. When exporting these products (technologies), the necessary procedures are to be taken in accordance with related laws and regulations.